

Calibre Wall basin hostess system 150mm

SUSSEX

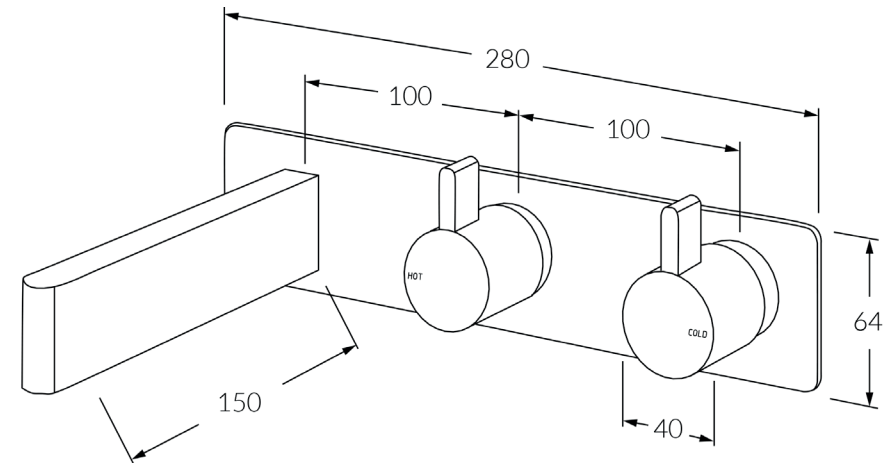
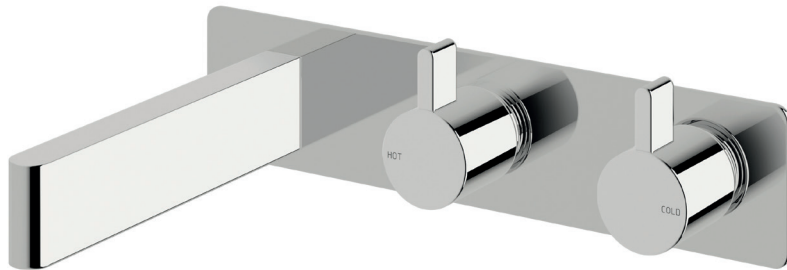

Product code

CWBHS150RH

Product features

- Designed and manufactured in Australia
- All brass construction
- 1/2 turn ceramic disc spindles
- Fixed handle lever
- Incorporating Sussex Masterfit
- Available in a range of high quality, durable finishes inc. LUXPVD®
- Minimal, refined design to complement any contemporary space
- Matching tapware and showers

Warranty

15 Year overall warranty.
Refer to Warranty sheet for specific information.

Pressure rating

300 - 500kPa

Temperature rating

1 - 65°C

WELS rating

5 star - 5lt/min

