

# Circa Vertex Wall basin mixer system 250mm

# SUSSEX

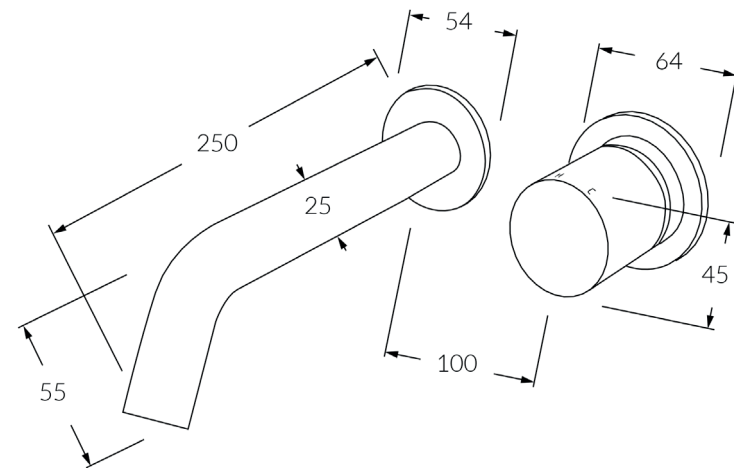

## Product code

RWBMS250RH-V

## Product features

- Designed and manufactured in Australia
- All brass construction
- Textured handle
- 35mm ceramic disc cartridge
- Customisable
- Incorporating Sussex Masterfit
- Available in a range of high quality, durable finishes inc. LUXPVD®
- Minimal, refined design to complement any contemporary space
- Matching tapware and showers

## Warranty

15 Year overall warranty.  
Refer to Warranty sheet for specific information.

## Pressure rating

300 - 500kPa

## Temperature rating

1 - 65°C

## WELS rating

5 star - 5.5lt/min