

Circa  
**Wall bath hostess system 250mm**

**SUSSEX**

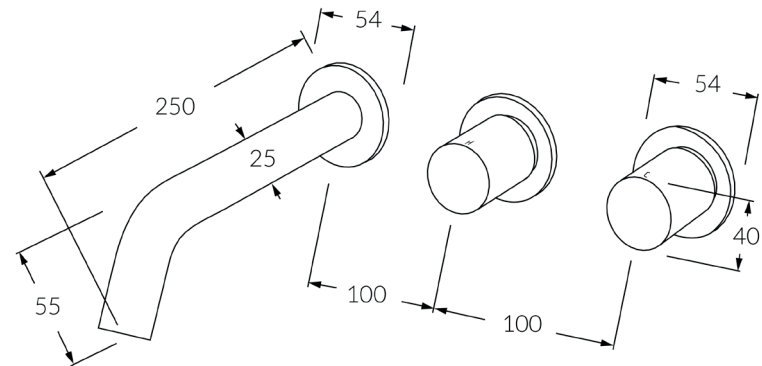

**Product code**

RBHS250RH

**Product features**

- Designed and manufactured in Australia
- All brass construction
- 1/2 turn ceramic disc spindles
- Incorporating Sussex Masterfit
- Customisable
- Available in a range of high quality, durable finishes inc. LUXPVD®
- Minimal, refined design to complement any contemporary space
- Matching tapware and showers

**Warranty**

15 Year overall warranty.  
Refer to Warranty sheet for specific information.

**Pressure rating**

300 - 500kPa

**Temperature rating**

1 - 65°C

