

Circa Bath mixer system with hand shower 150mm

SUSSEX

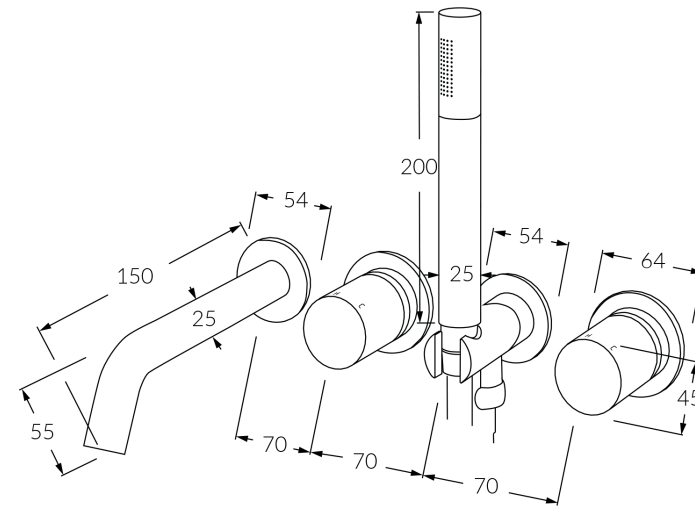

Product code

RBMS150RH

Product features

- Designed and manufactured in Australia
- All brass construction
- 35mm ceramic disc cartridge
- Incorporating Sussex Masterfit
- Available in a range of high quality, durable finishes inc. LUXPVD®
- Minimal, refined design to complement any contemporary space
- Matching tapware and showers

Warranty

15 Year overall warranty.
Refer to Warranty sheet for specific information.

Pressure rating

300 - 500kPa

Temperature rating

1 - 65°C

WELS rating

3 star - 8.5lt/min

