

Scala 25 bath outlet curved 200mm

SUSSEX

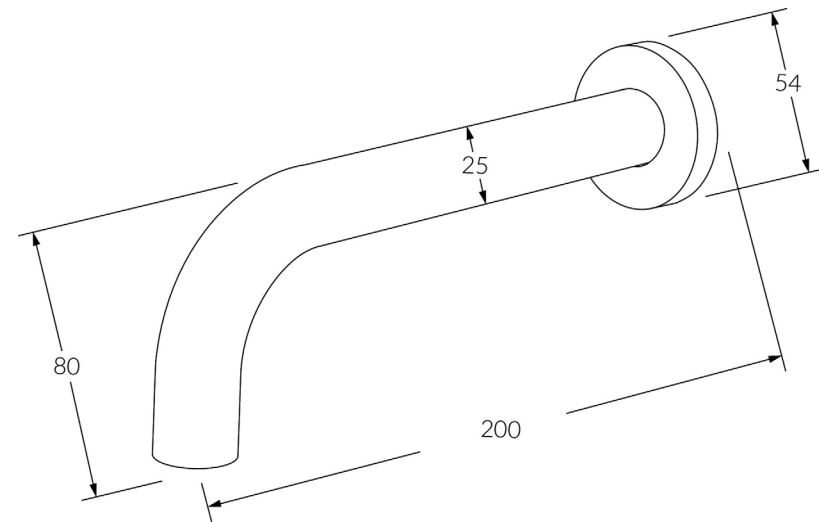
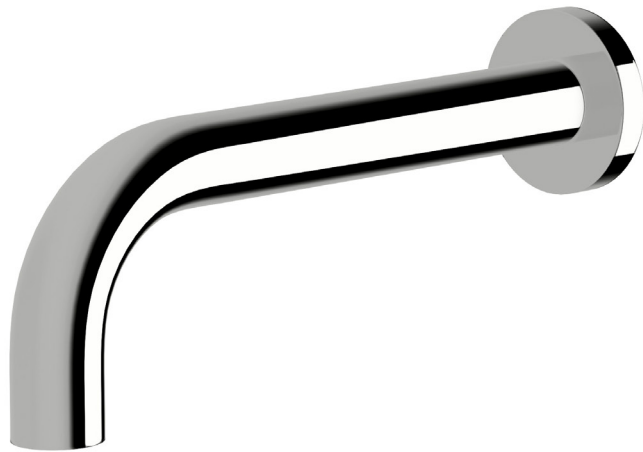

Product code

S25BA200

Product features

- Designed and manufactured in Australia
- All brass construction
- Retro fitable
- Customisable
- Available in a range of high quality, durable finishes inc. LUXPVD®
- Minimal, refined design to complement any contemporary space
- Matching tapware, showers and accessories

Warranty

15 Year overall warranty.
Refer to Warranty sheet for specific information.

Pressure rating

300 - 500kPa

Temperature rating

1 - 65°C

